

RADIO REMOTE CONTROL FFS230/FFS400

Operating Instructions



BJ 2015 ..
SN 1500 ..
FFS230
BA 0304882 R00 2021-06

Translation of operating instructions for the
Radio Remote Control FFS230/FFS400

MADE
IN
GERMANY



Cleantecs

 Basics	7
Safety notices	8
Explanatory information	9
Overview of the components and scope of delivery of the radio remote control	10
How does the radio remote control work?	12
Components and their function	13
Intended use	16
Improper and prohibited use	16
Requirements of the system user	16
Space requirements	16
Specifications for power connection	16
Power/technical specifications: 230 volts	16
Power/technical specifications: 400 volts	17
Where can the radio remote control be used?	17
Radio connection range	17
EC Declaration of Conformity	18
 Safety principles	19
For your safety	20
 Working safely	22
Working safely	23
Safe operating environment (current protection/FI)	23
Awareness of hazards in the working area	23



Radio range (what do I have to consider?)	23
Checking the radio remote control for defects	23
Checking the battery charge level of the handheld transmitter	23
Checking the function of the radio remote control	23
Safety when using the radio remote control	23

Commissioning 25

Preparation for connecting the radio remote control	26
Unpacking and checking new goods	26
Checking before connection	26
Charging the handheld transmitter	28

Working 30

Working with the radio remote control	31
The right place for radio reception	31
The right place for the base unit when working	32
Attaching the strap to the handheld transmitter	33
How do I connect the base unit?	34
How do I wear the strap with the handheld transmitter correctly?	34
Controls on the handheld transmitter	35
What does the GREEN LED indicate?	35
How do I operate the handheld transmitter?	37
How do I change the frequency band?	38

 Taking out of operation	40
Disconnecting the radio remote control	41
How do I disconnect the base unit from the device and the mains?	41
 Transport and storage	42
Transporting and storing the radio remote control	43
Preparation for transport	43
Preparation for storage	43
 Disposal	44
What happens to the waste?	45
Packaging	45
Base unit and handheld transmitter	45



A radio module from ELCA is integrated into our radio remote control. Please also read the ELCA operating instructions and keep them in a safe place.



It is **IMPORTANT** that you read these operating instructions **CAREFULLY BEFORE USE** and **KEEP THEM FOR FUTURE REFERENCE**.

Visit our homepage at regular intervals and check for the latest version of the operating instructions.

The operating instructions are intended for..

the radio remote control manufactured from 2015, serial number 1500. The revision level of the operating instructions is R00.



Components and functions of the radio remote control

Here you will find information about:
Components of the system, tools for maintenance.



Explanation of notices

Safety notices

The notices are for your safety. The notices can be found in the general safety section and are always accompanied by an action that requires specific attention.

 **DANGER**

Failure to comply will lead to serious injury or death.

 **WARNING**

Failure to comply may lead to serious injury or death.

 **CAUTION**

Failure to comply may lead to injuries.

NOTICE

Failure to comply may lead to material damage and impair the function of the product.

Note: ...

Additional information about product operation.



Explanatory information

This information can be found in the grey shaded area of a figure. It helps you to find the right figure for the heading in the text, understand the details better, follow steps, complete movements and identify the position.

Image title

The title of the image indicates the **text** to which the figure belongs.



The detailed view highlights areas that are important.

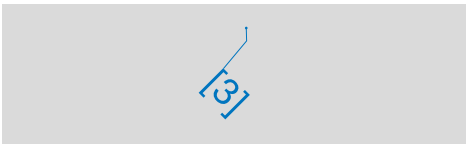

The numbers on the figures refer to the steps in the explanatory text. They always start again from [1] on each double page.

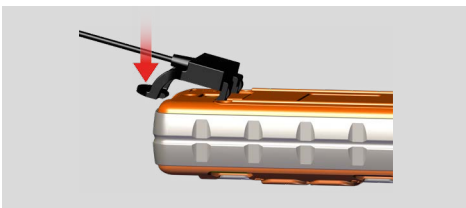

The red arrows always indicate a movement.



Overview of the components and scope of delivery of the radio remote control

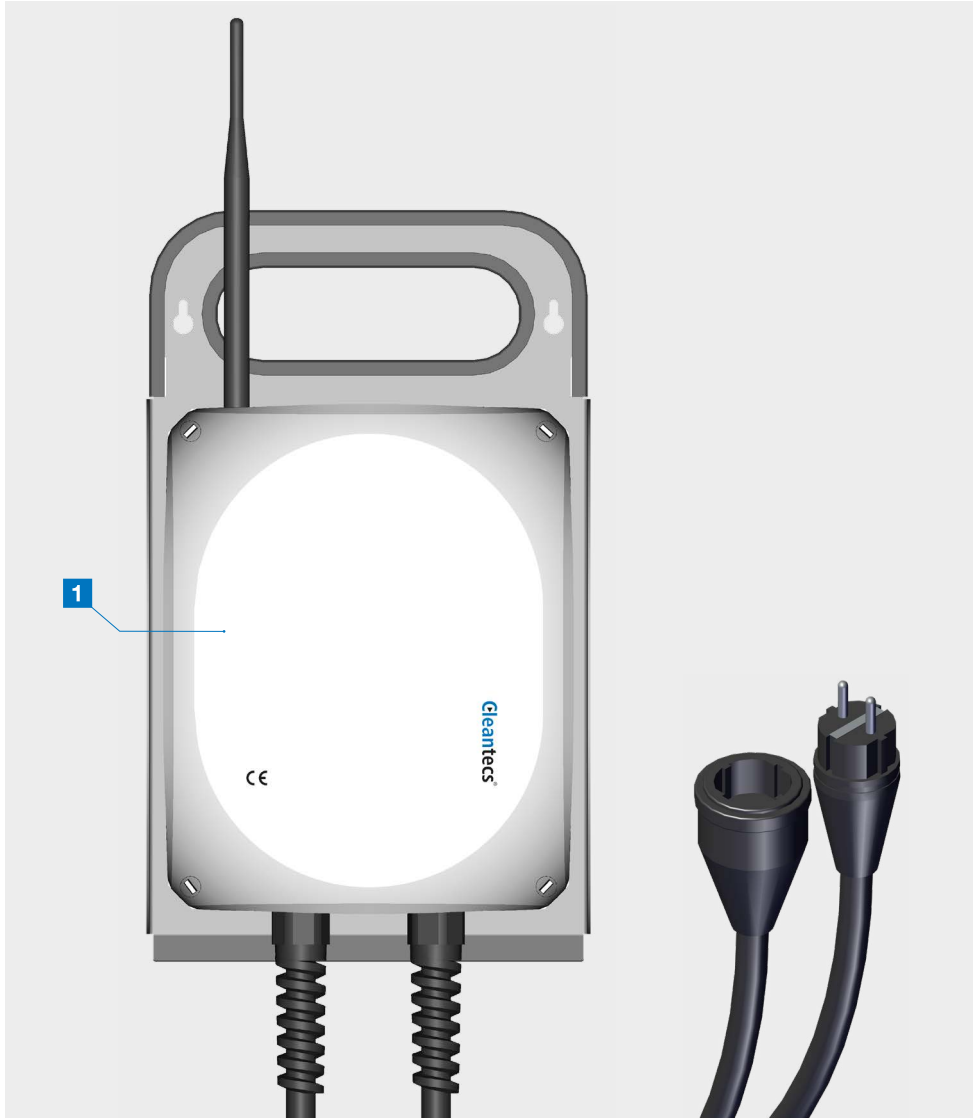



2



1 Radio remote control

2 Handheld transmitter

3 Charging unit for handheld transmitter

3



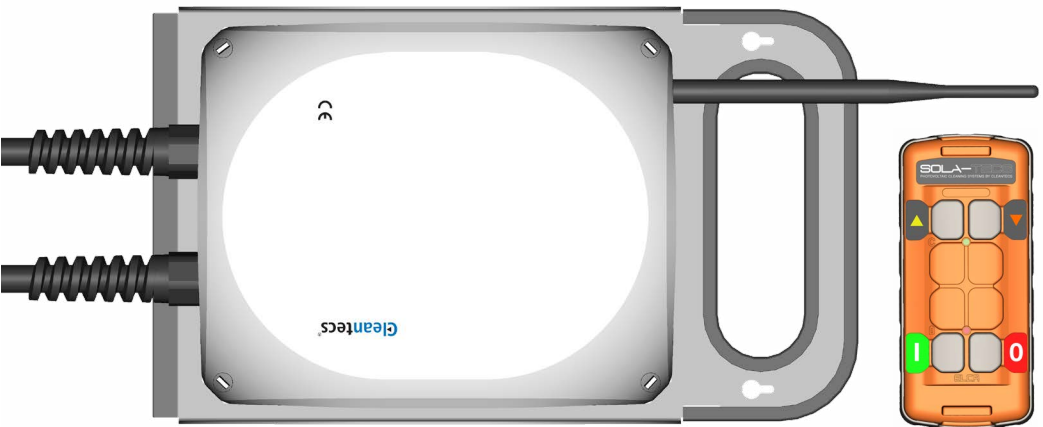

How does the radio remote control work?

The radio remote control consists of a housing with a radio receiver for receiving the radio signal and a contactor switch for switching the current.

A handheld transmitter is used for contactless operation. With the handheld transmitter, the contactor switch can connect or disconnect the flow of current without contact and from a distance (up to 270 metres). When the START button on the handheld transmitter is pressed, it searches for a frequency range for the best connection.

Once the best radio connection has been found, the handheld transmitter and radio receiver maintain permanent contact. If this contact is broken for any reason, a stop signal is automati-

cally activated for safety reasons and the contactor switch disconnects the power connection.

An antenna for receiving and transmitting radio signals is installed on the housing of the radio remote control. To increase the radio range, this can be replaced with an optimised antenna, which provides a range of up to 530 metres.



Housing

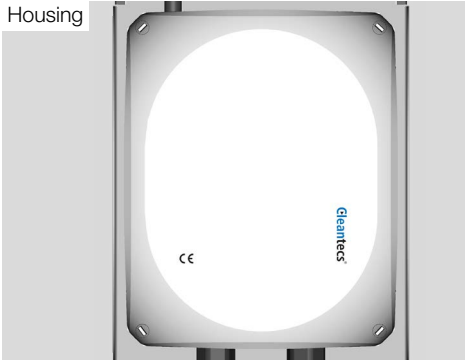

Handheld transmitter with strap



Antenna



Protective plate

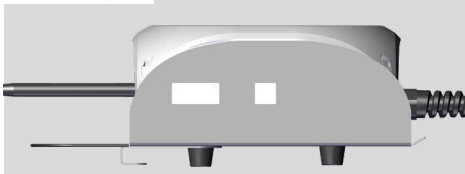

Components and their function

The radio receiver and the contactor switch are accommodated in the housing. The housing has protection classes IP66/IP67/IP69.

The handheld transmitter provides contactless control of the contactor switch via the receiver. The connection to the circuit is closed with the START button and broken with the STOP button. The arrow keys have no function.

The antenna provides a good radio connection up to 150 metres with obstacles and up to 270 metres without obstacles.

The protective plate protects the housing from mechanical stress and is used for transport and mounting options.

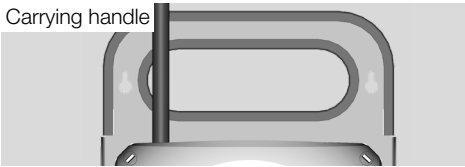

The carrying handle, which is integrated into the protective plate, helps to carry the radio remote control safely.



The suspension eyes offer the option of mounting the radio remote control on a surface.

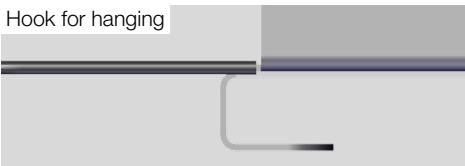

The hook can be used to hang the radio remote control on our DI filter trolley or in another suitable location.

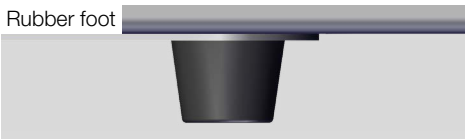

The rubber feet protect against dirt and provide slip resistance.

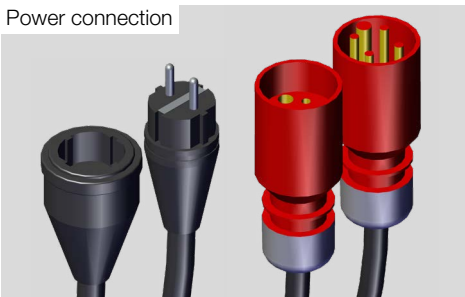

The connections connect to the mains and the device to be started and stopped.



The charging unit for the handheld transmitter is needed to charge the battery in the handheld transmitter.



Intended use

Here you will find the following information:
For what purposes may the FFS be used,
where may the FFS be used, who may use
the FFS?



Intended use

The FFS radio remote control is for STARTING and STOPPING devices in the commercial sector by means of a radio signal.

Improper and prohibited use

The FFS radio remote control must not be tampered with. No devices may be connected for which the required power consumption exceeds the possible power consumption of the radio remote control.

Requirements of the system user

The user of the radio remote control is in the commercial sector.

Operator: The operator must be instructed by the plant operator in the assigned tasks and possible dangers in case of improper conduct. The operator may only carry out tasks that go beyond normal operation if this is indicated in this manual and the plant operator has expressly instructed them to do so.

Qualified personnel: Due to their technical training, knowledge, experience and familiarity with the relevant standards and regulations, qualified personnel are able to carry out the work assigned to them, recognise possible dangers and avoid risks independently.

The following groups of people are not allowed to operate the radio remote control:

- ▶ People with limited physical, sensory or mental capacities
- ▶ Children and young people under 18 years of age
- ▶ Persons who have not been trained

Space requirements

- ▶ Space requirements for storage:
W 230 mm x L 140 mm x H 370 mm
- ▶ The following working area is required: W 230 mm x L 140 mm x H 370 mm

Specifications for power connection

The power connection must have a fuse rating of 230/400 volts and 16 amps. In addition, the power connection must have a residual current circuit breaker (FI or RCD).

Power/technical specifications: 230 volts

- ▶ Voltage 230 volts
- ▶ Current 16 amps
- ▶ Frequency 50/60 hertz
- ▶ Radio type ELCA AR MITO-MINI
- ▶ Operating frequency 868.0125 - 869.9875 MHz



Power/technical specifications: 400 volts

- ▶ Voltage 400 volts
- ▶ Current 16 amps
- ▶ Frequency 50/60 hertz
- ▶ Radio type ELCA AR MITO-MINI
- ▶ Operating frequency 868.0125 - 869.9875 MHz

Where can the radio remote control be used?

The housing of the radio remote control is approved according to protection class IP66/IP67/IP69. The housing is therefore dust-proof, can be submerged in water for short periods and can also withstand a high-pressure water jet. This allows the radio remote control to be used both indoors and outdoors.

Radio connection range

The radio connection range depends on the obstacles present in the radio path.

Range without obstacles:

- ▶ 270 metres

Range with obstacles:

- ▶ 150 metres

An antenna can be fitted to increase the range as an option.

Range without obstacles:

- ▶ 530 metres

Range with obstacles:

- ▶ 300 metres



EC Declaration of Conformity

Der Hersteller / Inverkehrbringer

Cleantecs GmbH
Grundweg 10
89250 Senden

erklärt hiermit, dass folgendes Produkt

Produktbezeichnung: FFS230, FFS400
Modellbezeichnung: FFS230 und FFS400
Seriennummer: ab 1500
Handelsbezeichnung: FS230, FFS400
Baujahr: 2015

allen einschlägigen Bestimmungen der angewandten Rechtsvorschriften (nachfolgend) - einschließlich deren zum Zeitpunkt der Erklärung geltenden Änderungen - entspricht. Die alleinige Verantwortung für die Ausstellung dieser Konformitätserklärung trägt der Hersteller.

Folgende harmonisierte Normen wurden angewandt:

EN 50106:2008	Sicherheit elektrischer Geräte für den Hausgebrauch und ähnliche Zwecke - Besondere Regeln für Stückprüfungen von Geräten im Anwendungsbereich der EN 60335-1
EN 60309-4:2007/A1:2012	Stecker, Steckdosen und Kupplungen für industrielle Anwendungen - Teil 4: Abschaltbare Steckdosen und Kupplungen mit oder ohne Verriegelung (IEC 60309-4:2006/A1:2012)
EN 60529:1991/A2:2013/AC:2019-02	Schutzarten durch Gehäuse (IP-Code) (IEC 60529:1989)
EN 60947-1:2007/A2:2014	Niederspannungsschaltgeräte - Teil 1: Allgemeine Festlegungen (IEC 60947-1:2007/A2:2014)
EN 61140:2002/A1:2006	Schutz gegen elektrischen Schlag - Gemeinsame Anforderungen für Anlagen und Betriebsmittel (IEC 61140:2001/A1:2004 (modifiziert))
EN 61293:1994	Kennzeichnung elektrischer Betriebsmittel mit Bemessungsdaten für die Stromversorgung - Anforderungen für die Sicherheit (IEC 61293:1994)

Folgende Rechtsvorschriften wurden angewandt:

Niederspannungsrichtlinie 2014/35/EU

Ort: Senden
Datum: 13.07.2021

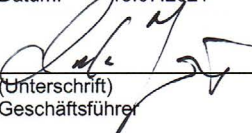

(Unterschrift)
Geschäftsführer



(Unterschrift)
Bevollmächtigter Technische Dokumentation



General safety instructions

Important instructions for safe use of the system and for ensuring safe cleaning.



For your safety

Important instructions for safe use of the system. These instructions enable you to protect yourself and others from dangerous situations and injuries.

DANGER



Danger to life due to inadequate fuse protection

- ▶ Operate the radio remote control only with a power supply system that has adequate fuse protection. This will prevent injury/death from electrocution.

DANGER



Danger to life due to missing residual current circuit breaker (FI)

- ▶ Operate the radio remote control only with a power supply system that has a residual current circuit breaker (FI). This will prevent injury/death from electrocution.

DANGER



Danger to life due to defect

- ▶ In the event of a defect, first disconnect the radio remote control from the mains. This will prevent injury/death from electrocution.

DANGER



Danger to life due to defective components

- ▶ Before putting into operation, check the housing, cables, connections and strap for damage. Damage must be repaired or replaced with original parts. This will prevent injury/death from electrocution.

WARNING



Report malfunction

- ▶ Report malfunctions to your supervisor immediately. This will prevent injuries or damage.



CAUTION



Risk of injury due to falling

- ▶ Check your working area for unevenness and obstacles.
This will protect you from injuries resulting from a fall.

NOTICE

Avoid loss of radio signal

- ▶ Make sure that you are within the radio range of the transmitting and receiving unit.
This will ensure that the radio remote control is working properly.

NOTICE

Warranty invalidation

- ▶ Do not break the seal of the housing.
This will invalidate the warranty.



Safe operation

Here you will find information about: choosing a safe cleaning location, sources of danger in the working area, sources of danger when working.



Working safely

Here you will find a description of how to work safely with the radio remote control.

Safe operating environment (current protection/FI)

- ▶ Check the fuse of your power connection. The fuse must match the power specifications for the radio remote control.
- ▶ Check that the circuit in which your power connection is located has a residual current circuit breaker (FI).

Awareness of hazards in the working area

- ▶ Ensure that there are no trip hazards in your working environment.
- ▶ Ensure that you do not create any trip hazards with your equipment.

Radio range (what do I have to consider?)

- ▶ Ensure that there are as few obstacles as possible in the area of the radio link.
- ▶ Obstacles made of metal or concrete in particular can severely restrict the radio link and thus the range.

Checking the radio remote control for defects

Before starting work, check the radio remote control for damage ..

- ▶ ... to the housing
- ▶ ... to cables
- ▶ ... to connections
- ▶ ... to the antenna
- ▶ ... to the handheld transmitter

Checking the battery charge level of the handheld transmitter

- ▶ Check the battery charge status of the handheld transmitter before starting work.

Checking the function of the radio remote control

- ▶ Check the function of the radio remote control before starting work.

Safety when using the radio remote control

- ▶ Beware of interruptions to the radio connection.

DANGER

Danger to life due to missing residual current circuit breaker (FI)

- ▶ Operate the radio remote control only with a power supply system that has a residual current circuit breaker (FI). This will prevent injury/death from electrocution.

WARNING

Prevent dangerous situations in the event of malfunctions

- ▶ In dangerous situations, switch off the radio remote control by pressing the STOP button on the handheld transmitter. This will prevent injuries and damage.



NOTICE

Check function

- ▶ Test the function of the radio remote control before starting work. This will prevent malfunctions when working.

NOTICE

Damage due to incorrect use

- ▶ Use the radio remote control only for its intended purpose. This will prevent damage to the radio remote control.

NOTICE

Avoid loss of radio signal

- ▶ Make sure that you are within the radio range of the transmitting and receiving unit. This will ensure that the radio remote control is working properly.

NOTICE

Avoid failure during work

- ▶ Operate the radio remote control only with a charged handheld transmitter. This will prevent failures during work.

NOTICE

Avoid damage to the handheld transmitter

- ▶ Use the handheld transmitter only with the strap supplied. This will prevent damage to the handheld transmitter if dropped.



Commissioning the radio remote control

Here you will find information about preparing the FFS for operation.



Check for damage

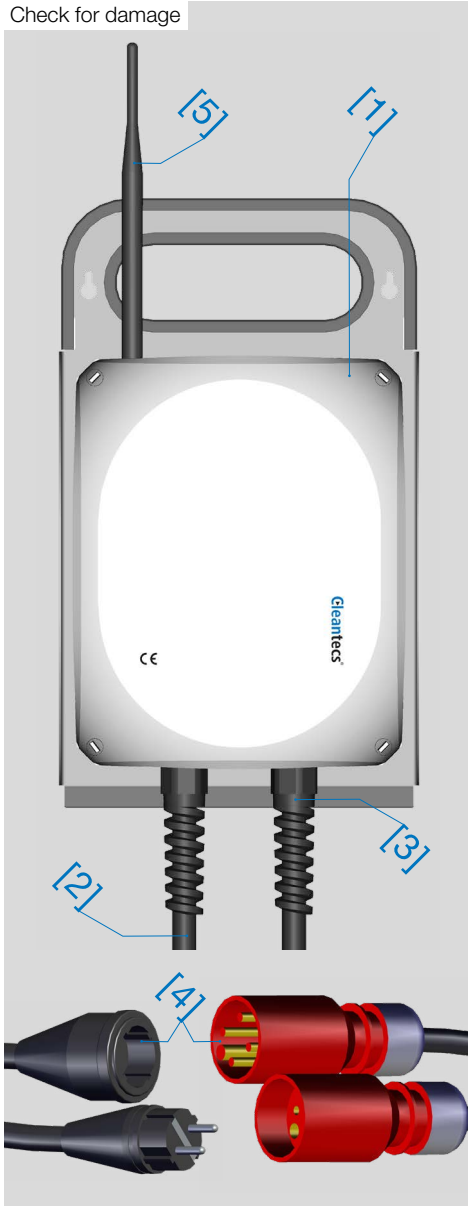

Preparation for connecting the radio remote control

In this step, the radio remote control is prepared for connection.

Unpacking and checking new goods

► After unpacking the radio remote control, please check that all components are present and that there is no damage.

Checking before connection

► Always check the radio remote control for damage before connecting it, including the following:

- the housing [1] for cracks or holes
- the cables [2] for cracks
- the connections of the cables [3] on the housing for breakage and tight fit

⚠ DANGER

Danger to life due to defective components

- Before putting into operation, check the housing, cables, connections and strap for damage. Damage must be repaired or replaced with original parts.

This will prevent injury/death from electrocution.



Check for damage



- ▶ the plug connections [4] for bent contacts, cracks, correct fit of cable and plug connections.
- ▶ the antenna [5] for cracks and breaks.
- ▶ the handheld transmitter [6] for damage to the housing, for cracks in the membrane keys, for charging status of the battery.
- ▶ the strap [7] of the handheld transmitter for cracks and defective fastenings.

DANGER

Danger to life due to missing residual current circuit breaker (FI)

- ▶ Operate the radio remote control only with a power supply system that has a residual current circuit breaker (FI). This will prevent injury/death from electrocution.

NOTICE

Avoid failure during work

- ▶ Operate the radio remote control only with a charged handheld transmitter. This will prevent failures during work.

NOTICE

Avoid damage to the handheld transmitter

- ▶ Use the handheld transmitter only with the strap supplied. This will prevent damage to the handheld transmitter if dropped.



Disconnect the power supply unit from the mains

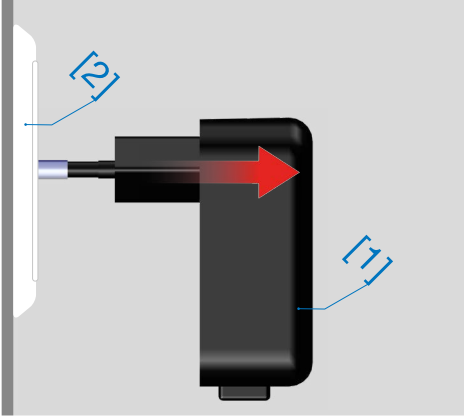

Check contacts

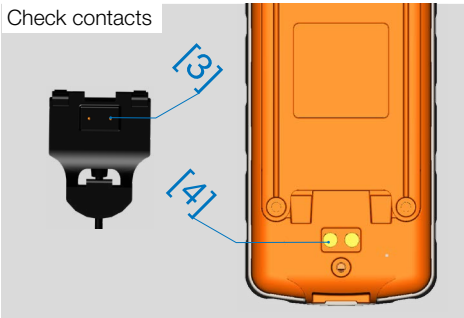

Fit the charging clip

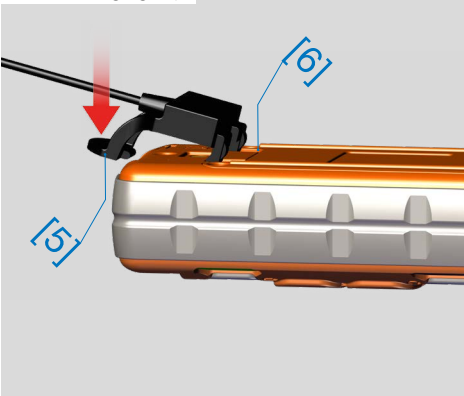

Charging the handheld transmitter

The handheld transmitter is equipped with a lithium polymer battery. This cannot be removed, but is charged with the charging unit supplied.

Charging should be carried out at a temperature between 0 °C and 45 °C. Outside this temperature range, the charging process is interrupted. It restarts when the temperature is within the temperature range.

The handheld transmitter should always be fully charged before starting work. In regular use, always connect the handheld transmitter to the charger when you finish work.

Charging the handheld transmitter:

- ▶ Disconnect the power supply unit [1] of the charging device from the power supply [2].
- ▶ Check contacts on charging clip [3] and handheld transmitter [4] for dirt and moisture. If necessary, clean and dry.
- ▶ Attach charging clip [5] to handheld transmitter [6].

WARNING

Only with dry hands

- ▶ Do not connect the charger with wet or damp hands. This will prevent injuries from electric shock.



Power supply unit with charging clip, then connect to power supply

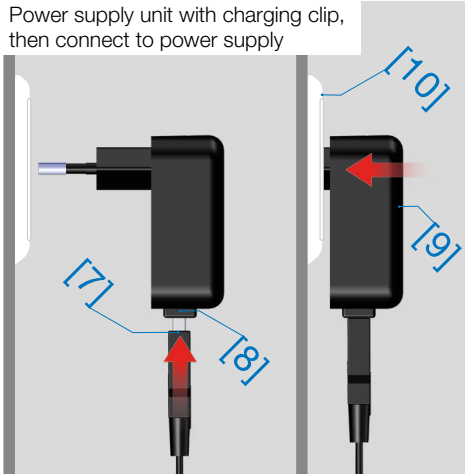

- ▶ Connect charging clip cable [7] to power supply unit [8].
- ▶ Connect power supply unit [9] to power supply [10].
- ▶ Check that the lower LED [11] on the handheld transmitter [12] turns “RED”.

If the LED does not turn “RED”, the handheld transmitter is charged or the temperature is outside the temperature range.

- ▶ If the “RED” LED is illuminated, charge the handheld transmitter (approx. 4 hours).

INFO: The lithium polymer battery charges quickly at first, so that 50% of the charging capacity is reached after one hour. Charge the battery regularly, at least once a year.

- ▶ After charging, disconnect the mains adapter from the power supply and remove the charging clip.

ATTENTION: The lithium polymer battery may only be replaced by ELCA or a dealer approved by ELCA.

Check LED

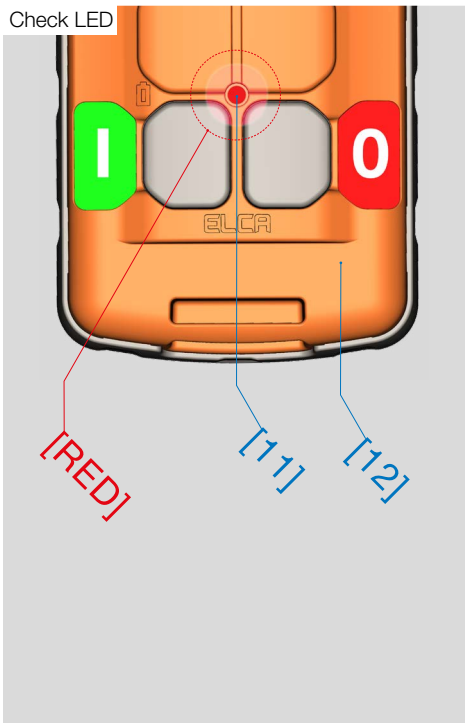

WARNING

Check for damage

- ▶ Before charging, check the charging unit and power supply unit for damage and dirt. This will prevent injuries from electric shock and damage due to dirt particles.



Working with the radio remote control

Here you will find information about working with the radio remote control.



Radio range

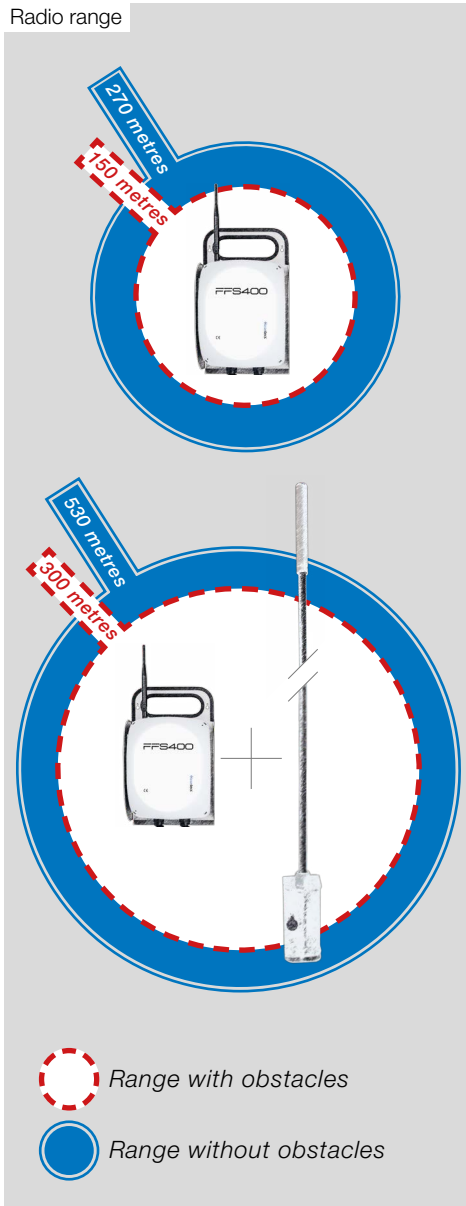

Working with the radio remote control

This section describes how to work with the radio remote control:

- ▶ How do I assess the right place for radio reception?
- ▶ Where and how do I properly attach or position the base unit?
- ▶ How do I wear the strap with the handheld transmitter correctly?
- ▶ How do I connect the base unit?
- ▶ How do I wear the strap correctly?
- ▶ How do I operate the handheld transmitter?

The right place for radio reception

The ideal place for radio reception is always where there is a direct line of sight with the base unit. Since this is not always feasible, the possible reception distance varies between 150 metres with obstacles and 270 metres with a line of sight.

TIP: For difficult reception conditions, there is an optional antenna that offers a range of up to 300 metres in the presence of obstacles and up to 530 metres with a line of sight.

NOTICE

Avoid loss of radio signal

- ▶ Make sure that you are within the radio range of the transmitting and receiving unit.

This will ensure that the radio remote control is working properly.



Suspension eyes

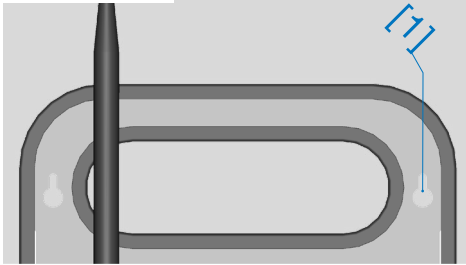

Hook on back

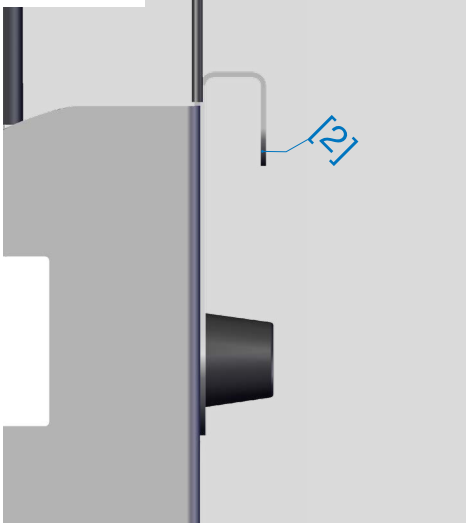

Rubber feet for positioning

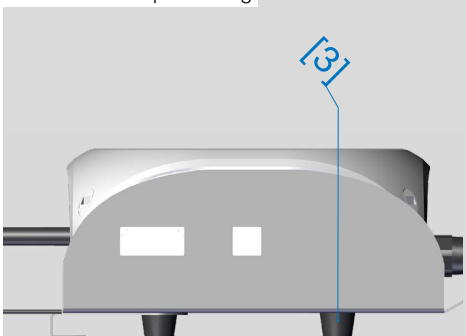

The right place for the base unit when working

The base unit should be positioned in a location that is protected from dirt and water. Do not lay the cables with the plugs in dirt or water and do not create a possible trip hazard. The base unit can be attached or positioned as follows:

► **[1] The suspension eyes in the protective plate.** You can use the suspension eyes to attach the base unit to a vertical surface.

► **[2] The hook on the back of the protective plate.** This hook can be used to hang the base unit in a suitable location.

TIP: Our DI filter trolley has a specific place for hanging the base unit.

► **[3] The rubber feet on the back of the protective plate.** You can set the base unit on its rubber feet if there is no option to hang it up. The base unit should not be positioned in dirt or moisture and should not create a tripping hazard.

NOTICE

Avoid damage to the connection cables

- Operate the radio remote control only when it is hanging from a suspension device or positioned on a clean surface.

This will prevent damage to the connection cable.



Thread the strap through

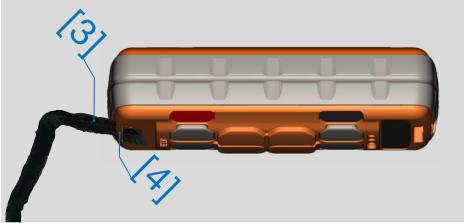

Form loop

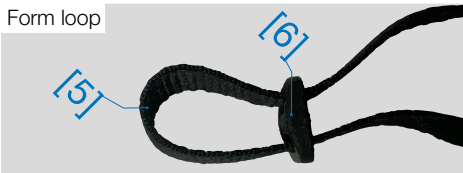

Thread into adjustment clasp

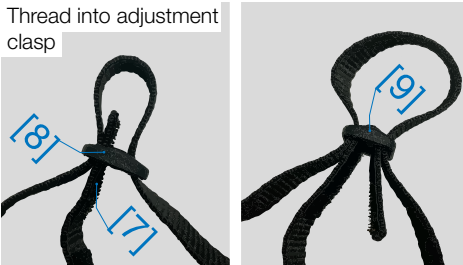

Fasten with Velcro

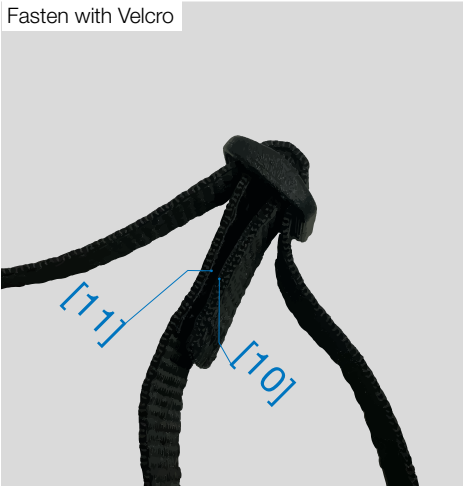

Attaching the strap to the handheld transmitter

- ▶ Thread the end with the Velcro [3] through the eyelet [4] of the handheld transmitter.
- ▶ Pull the belt [5] through the adjustment clasp [6] until it forms a loop.
- ▶ Thread the end of the belt [7] through the adjustment clasp [8] over the bar to the Velcro fastening [9].
- ▶ Press the Velcro hook [10] and Velcro pad [11] together.
- ▶ Repeat attachment on the other side.

NOTICE

Avoid damage to the handheld transmitter

- ▶ Use the handheld transmitter only with the strap supplied. This will prevent damage to the handheld transmitter if dropped.



Connecting the device

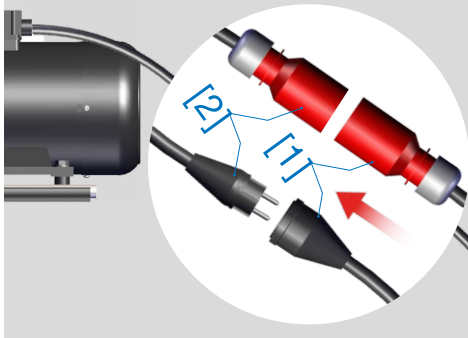

Connect to power supply

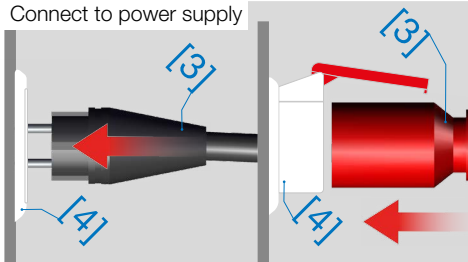

Carrying handheld transmitter



How do I connect the base unit?

When connecting the base unit, proceed as follows:

- ▶ Connect the base unit [1] to the device [2] that you want to control.
- ▶ Connect the base unit [3] to the mains [4].

How do I wear the strap with the handheld transmitter correctly?

The handheld transmitter [5] must be worn with the strap [6] during use.

The handheld transmitter should be worn with the START and STOP button facing the hip.

DANGER

Danger to life due to missing residual current circuit breaker (FI)

- ▶ Operate the radio remote control only with a power supply system that has a residual current circuit breaker (FI). This will prevent injury/death from electrocution.

DANGER

Danger to life due to inadequate fuse protection

- ▶ Operate the radio remote control only with a power supply system that has adequate fuse protection. This will prevent injury/death from electrocution.



Controls

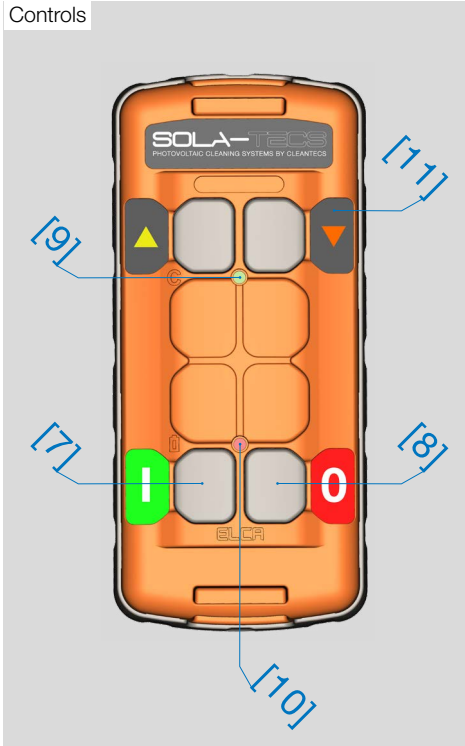

Controls on the handheld transmitter

The function of the handheld transmitter is to send a START and a STOP signal and to ensure that a stable signal can be transmitted by permanent radio contact with the receiving unit.

The following controls are provided:

- ▶ [7] START – switches the device on.
- ▶ [8] STOP – switches the device off.
- ▶ [9] LED GREEN – indicates the operating status and the charge status of the lithium polymer battery.
- ▶ [10] LED RED – shows the status during charging (see page 29).
- ▶ [11] The keys with the arrows are disabled.

What does the GREEN LED indicate?

Operating status:

- ▶ [12] LED off – handheld transmitter switched off.
- ▶ [13] LED flashing – handheld transmitter switched on.

Handheld transmitter off

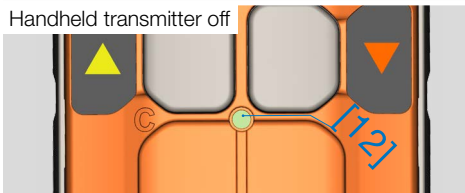

Handheld transmitter switched on

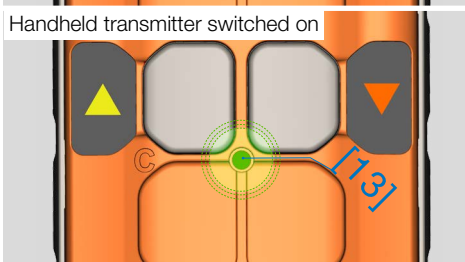

⚠ CAUTION

Quick access to handheld transmitter

- ▶ Use the handheld transmitter only with the strap supplied. This will ensure that the handheld transmitter can be found quickly for fast access.



Handheld transmitter charged

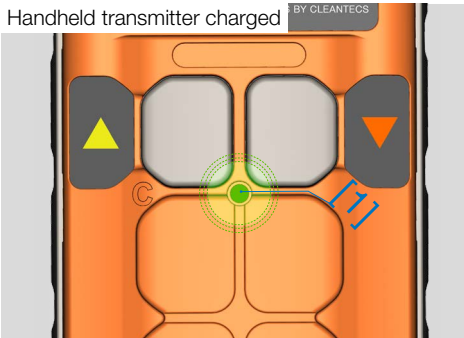

Handheld transmitter battery low

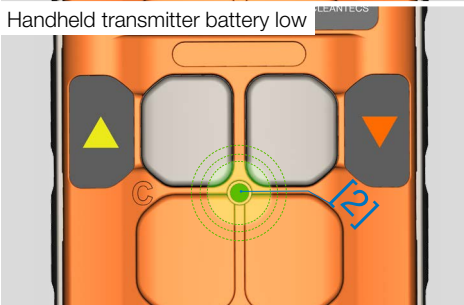

Handheld transmitter battery flat

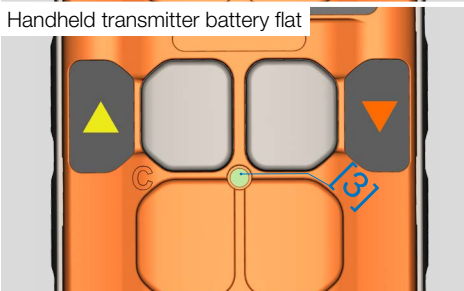

Handheld transmitter radio connection interrupted

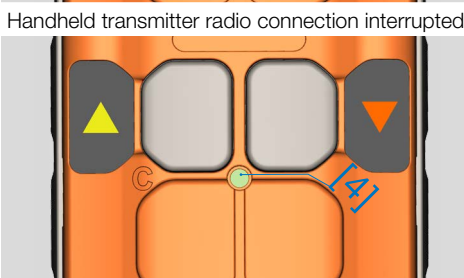

Capacity of the lithium polymer battery:

- ▶ [1] LED flashing at 1 second intervals – the battery is charged.
- ▶ [2] LED flashing at 2 second intervals – the battery is almost flat.
- ▶ [3] LED goes off during operation – the battery is flat.

Radio connection interference:

- ▶ [4] LED goes off during operation – radio connection interrupted.

WARNING

Report malfunction

- ▶ Report malfunctions to your supervisor immediately. This will prevent injuries or damage.

NOTICE

Check function

- ▶ Test the function of the radio remote control before starting work. This will prevent malfunctions when working.



Start device

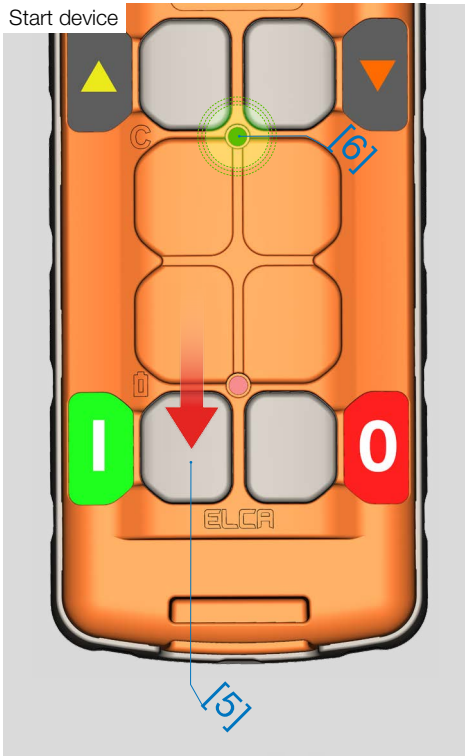

How do I operate the handheld transmitter?

- ▶ To start a device, press the START button [5] until the GREEN LED [6] starts to flash brightly.
- ▶ To stop a device, press the STOP button [7].

WARNING

Press the STOP button in dangerous situations

- ▶ In the event of malfunctions, switch off the radio remote control using the STOP button on the handheld transmitter and disconnect the receiver unit from the power supply. This will prevent unpredictable dangerous situations.

WARNING

Prevent dangerous situations in the event of malfunctions

- ▶ In dangerous situations, switch off the radio remote control by pressing the STOP button on the handheld transmitter. This will prevent injuries and damage.

Stop device

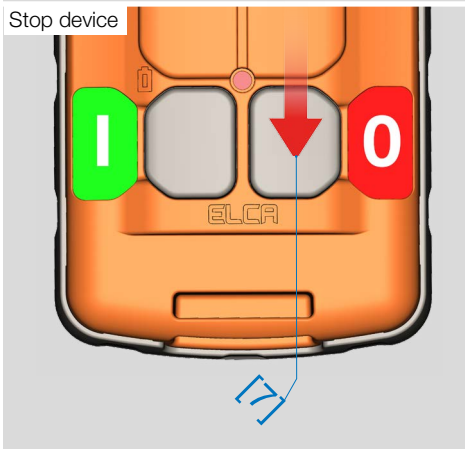



Frequency groups

GROUP	FREQUENCIES
Group 1	869.7125 - 869.8125 - 869.9375 MHz
Group 2	869.7625 - 869.8625 - 869.9875 MHz
Group 3	869.7375 - 869.8375 - 869.9625 MHz

Start frequency group change

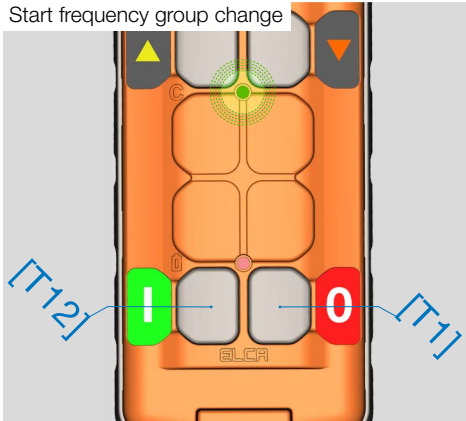

Frequency group change

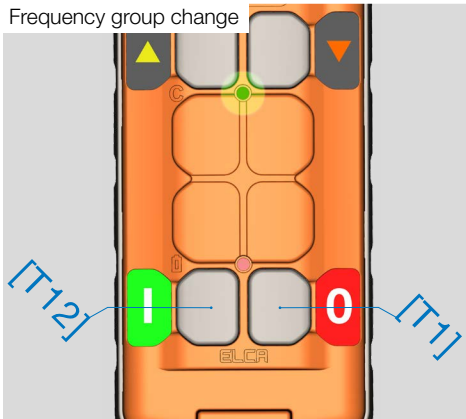

How do I change the frequency band?

The radio remote control has the option to switch between three frequency groups. Changing to another frequency group is permanent.

Changing the frequency group may be necessary:

- ▶ if you operate several radio remote controls and they interfere with one another's radio connection.
- ▶ if other radio signals in the working environment interfere with the radio connection.

The procedure below allows you to set the frequency group that matches the one set on the radio remote control:

- ▶ With the transmitting unit switched off, press and hold the **T12** button and then press the **T1** button within 1 second. Keep both held down until the GREEN LED has flashed for 5 seconds and then lights up.

- ▶ To change to the next frequency group, press the **T1** key. The GREEN



Change frequency group

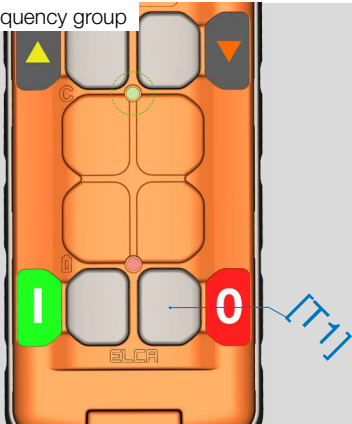

LED flashes once, then the transmitter unit switches off.

Repeat the procedure to change again to the next frequency group.



Taking the radio remote control out of operation

Here you will find information about dismantling the radio remote control.



Disconnect from the power supply

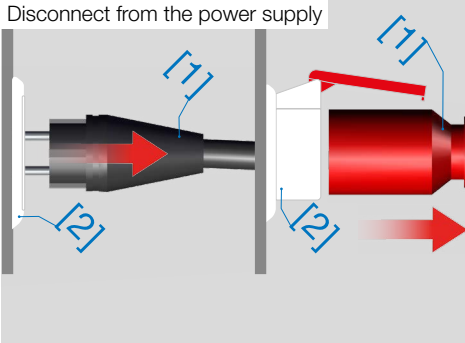

Disconnect from the device

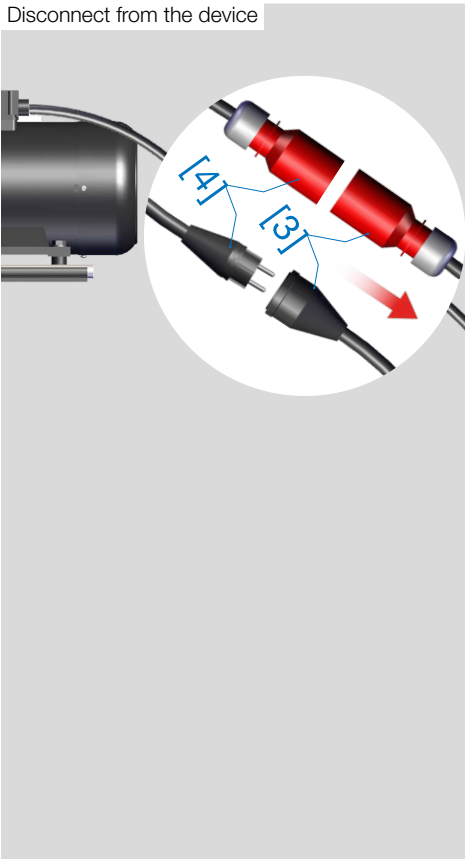

Disconnecting the radio remote control

Here you will find a description of disconnecting the radio remote control.

How do I disconnect the base unit from the device and the mains?

When disconnecting the base unit, proceed as follows:

- ▶ Disconnect the base unit [1] from the mains [2].
- ▶ Disconnect the base unit [3] from the device [4] it was controlling.

ATTENTION:

*Check the plugs and cables for dirt.
Clean them if necessary.*



Transport and storage

Here you will find information about transporting and storing the system.



Check for damage and contamination



Transporting and storing the radio remote control

Transport and storage of the radio remote control are described here.

Preparation for transport

- ▶ Check the radio remote control for damage (housing, cable, plugs, antenna, handheld transmitter, strap).
- ▶ Check the radio remote control for dirt (housing, cable, plugs, antenna, handheld transmitter) and clean if necessary.
- ▶ Move the radio remote control to a safe, clean place.

Preparation for storage

- ▶ Check the functioning of the radio remote control.
- ▶ Check the radio remote control for damage (housing, cable, plugs, antenna, handheld transmitter, strap).
- ▶ Check the radio remote control for dirt (housing, cable, plugs, antenna, handheld transmitter) and clean if necessary.
- ▶ Store the radio remote control in a safe, clean place.



Disposing of the system

Here you will find information about disposal of the product and the associated components.



What happens to the waste?

Packaging

▶ The packaging is made of cardboard and can be recycled.

Base unit and handheld transmitter

▶ The base unit and the handheld transmitter must be disposed of using the locally approved electrical appliance recycling system.



CAUTION

Risk of injury during disassembly

▶ Wear gloves during disassembly. This will protect your skin from abrasions and pinching.



Notes

10/10/21

A large grid of blue dots for taking notes.



Notes

Handwriting practice area with a grid of dots and a margin line.

